



# User Manual

SPI500K-B (V4.1-V4.3)



**Copyright © Xiamen Kehua Hengsheng Co., Ltd. 2016. All rights reserved.**

No part of this document may be reproduced or transmitted in any form or by any means without prior written consent of Xiamen Kehua Hengsheng Co., Ltd.

### **Trademarks and Permissions**



and other Kehua trademarks are trademarks of Xiamen Kehua Hengsheng Co., Ltd.

All other trademarks and trade names mentioned in this document are the property of their respective holders.

### **Notice**

The purchased products, services and features are stipulated by the contract made between Kehua and the customer. All or part of the products, services and features described in this document may not be within the purchase scope or the usage scope. Unless otherwise specification in the contract, all statements, information, and recommendations in this document are provided "AS IS" without warranties, guarantees or representations of any kind, either express or implied.

The information in this document is subject to change without notice. Every effort has been made in the preparation of this document to ensure accuracy of the contents, but all statements, information, and recommendations in this document do not constitute a warranty of any kind, express or implied.

## **XIAMENKEHUA HENGSHENG CO., LTD.**

Address:	No.457, Malong Road, Torch High-Tech Industrial Zone, Xiamen, Fujian, China
Postal Code:	361000(XIAMEN)
Website:	<a href="http://www.kehua.com">www.kehua.com</a>
E-mail:	<a href="mailto:service@kehua.com">service@kehua.com</a>
The Customer Service Telephone:	400-808-9986
Tel:	0592-5160516
Fax:	0592-5162166

# Foreword

## Summaries







Thank you for choosing the Kehua SPI Series products! This manual is suitable for SPI500K (V4.1-V4.3) series indoor grid-connected inverter.

This document gives a description of the product, including the inverter features, performance, appearance, structure, working principles, installation, operation and maintenance .etc.

Please save the information after reading, in order to consult in the future.

## Symbol Conventions

The manual quotes the safety symbols, these symbols used to prompt users to comply with safety matters during installation, operation and maintenance. Safety symbol meaning as follows.

Symbol	Description
 <b>DANGER</b>	Alerts you to a high risk hazard that could, if not avoided, result in serious injury or death.
 <b>WARNING</b>	Alerts you to a medium or low risk hazard that could, if not avoided, result in moderate or minor injury.
 <b>CAUTION</b>	Alerts you to a potentially hazardous situation that could, if not avoided, result in equipment damage, data loss, performance deterioration, or unanticipated results.
	Anti-static prompting.
	Be care electric shock prompting.
 <b>TIP</b>	Provides a tip that may help you solve a problem or save time.
 <b>NOTE</b>	Provides additional information to emphasize or supplement important points in the main text.

Product standard: Q-XMHS003-2015

## Change History

Changes between document issues are cumulative. The latest document issue contains all the changes made in earlier issues.

### Issue 001 (2016-10-14)

First issue.

# Contents

<b>1 Safety Description.....</b>	<b>1</b>
1.1 Safety Announcements.....	1
<b>2 Overview.....</b>	<b>3</b>
2.1 Product Intro.....	3
2.1.1 Features.....	3
2.1.2 Nameplate.....	4
2.1.3 Product Difference.....	5
2.2 Appearance and Panel.....	5
2.2.1 Appearance.....	5
2.2.2 Panel.....	5
2.3 Component Description.....	7
2.3.1 DC Disconnecter.....	7
2.3.2 AC Disconnecter.....	7
2.3.3 Fuse of DC Sideand AC Side.....	7
2.4 Work Principle.....	8
2.5 Working Modes.....	10
2.6 Monitoring Mode.....	11
2.6.1 Monitor by RS485 Information Collector.....	11
2.6.2 Computer Monitor by RS485.....	12
<b>3 Installation.....</b>	<b>13</b>
3.1 Unpacking and Checking.....	13
3.2 Installation Preparation.....	13
3.2.1 Tools.....	13
3.2.2 Installation Environment.....	15

3.2.3 Installation Clearance.....	16
3.2.4 Heat Dissipation Requirements for Installing Environment .....	17
3.3 Transportation .....	18
3.3.1 Forklift Transportation .....	18
3.3.2 Lifting Transportation .....	19
3.4 Installation Procedure.....	20
3.5 Electrical Connection .....	23
3.5.1 Wiring Requirements .....	23
3.5.2 Wiring Procedure .....	24
<b>4 Operation Guide .....</b>	<b>28</b>
4.1 Function of Touch Screen.....	28
4.2 Menu Structure of LCD Touch Screen .....	29
4.3 Main Page .....	30
4.4 Login .....	31
4.5 ON/OFF Operation.....	33
4.5.1 ON Operation.....	33
4.5.2 OFF Operation .....	34
4.6 Running Parameters Display .....	34
4.6.1 Look Up Operation Procedure .....	34
4.7 Preferences .....	35
4.8 Engineering Setting .....	37
4.9 NowFault Inquiry .....	39
4.10 History Information.....	40
4.11 Recover to Factory Setting .....	40
<b>5 System Commissioning .....</b>	<b>42</b>
5.1 Manual Operation.....	42
5.1.1 Check Before Operating.....	42
5.1.2 Startup Procedure.....	42
5.2 Self-starting .....	44

---

<b>6 Routine Maintenance .....</b>	<b>45</b>
6.1 Machine Room Management .....	45
6.2 Maintenance Guide .....	46
6.3 Safety Precautions .....	46
6.4 Preventive Maintenance .....	46
6.5 Maintenance Operation Procedure .....	47
<b>7 Troubleshooting.....</b>	<b>48</b>
7.1 Rectifying Common Faults .....	48
<b>A Technical Specifications .....</b>	<b>51</b>
<b>B Acronyms and Abbreviations .....</b>	<b>54</b>



# 1 Safety Description

This chapter describes the safety symbols and safety announcements. Please read this user manual carefully prior to installing the device, and operate and install according to the instructions described in the manual to avoid human dangerous or device damage. Any equipment damage caused by violating the common safety operation requirements or safety standards of design, producing, and using will be out of Xiamen Kehua's warranty range.

## 1.1 Safety Announcements

- There is no operational part inside the inverter. Please do not open the crust of the inverter by yourself, or it may cause electric shock. The inverter damage caused by illegal operation is out of the guarantee range.
- All operation and wiring should be performed by professionals with corresponding qualification, which is to ensure that all the electric installation accord with the standard of electric installation.
- Before checking or maintenance, if the DC side and AC side is power down just now, it is necessary to wait for 20 minutes to ensure the inner inverter is completely discharged, and then the operation can be performed.
- When install the PV array in daytime, it necessary to cover the solar battery array by light-proof material, or the solar battery array will generate high voltage under the sunshine.
- The operation environment may influence the life span and reliability of the inverter. So, please avoid to use the inverter in following environment:
- The place where temperature and humidity beyond the technical specifications (temperature:  $-25^{\circ}\text{C} \sim 55^{\circ}\text{C}$ );
  - The place with direct sunshine or rain;
  - The place with vibration or impact;
  - The place with dust, corrosive materials, salt or burnable gas;
  - The place with bad ventilation or closed situation;

- The place where close to resident living quarter.
- No liquid or other objects are allowed to enter the cabinet.
- High leakage risk! The inverter must be grounded before electrical connection. The ground terminal must be connected to the ground.
- The product is grade A device. If the product is used in resident living, it may cause wireless interference. User should take actions to avoid the interference.
- The product may cause DC current in external protective earthing conductor. If adopts residual current device (RCD) or monitor (RCM) as the protection of direct or indirect contacting, the type B RCD or RCM can be used only in the input end of the product.
- Please do not put finger or tool into rotating fans to avoid endanger the human safety or damage the inverter.
- In case fire, please use dry power fire extinguisher. if using liquid fire extinguisher, it may cause electric shock.
- Before contact the sensitive component, please wear anti-static rings and well connect the other end of the anti-static rings to ground.

## 2 Overview

This chapter mainly introduces the product features, appearance, operation panel, work principle, work modes, etc.

### 2.1 Product Intro

The grid-connected inverter is used as the PV grid-connected inverter in PV grid-connected power generation system. In the system, grid-connected inverter could always make the solar battery plate output the maximum power, and transform output energy and transmit to grid. The PV grid-connected power generation system consists of PV modules, PV junction box, and PV grid-connected inverter, metering device and power distribution system, as shown in Figure 2-1.

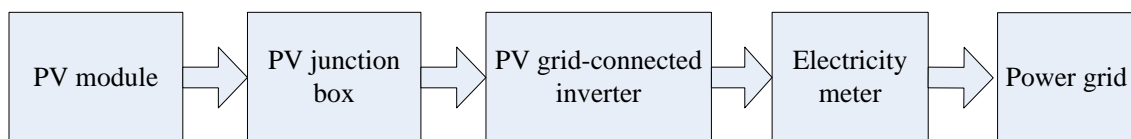

Figure 2-1 PV grid-connected power generation system



#### CAUTION

The PV grid-connected power generation should be allowed by local power supply department and operate by professionals.

#### 2.1.1 Features

- Wide input voltage range.
- Output adopts LC filtering way.
- Adopt advanced IGBT power module
- Adopt the safe and reliable DSP+CPLD control architecture and fiber transmission.
- The busbar adopt the film capacitance to ensure the equipment's working life.

- Sine wave output, automatic synchronism grid, small current harmonic, non-pollution and impact for grid.
- Adopt disturbance detection technology to realize the anti-islanding operation protection.
- Perfect protection function and high reliability.
- Excellent thermal design, lower temperature-rise and longer service life.
- Adopting advanced MPPT algorithms - MPPT efficiency 99.9%.
- LCD touch screen and multi-language interface setting
- Can be monitored by RS232/RS485 communication port
- Protection and operation parameters setting
- Modular design, easy to install ,operate and maintain
- Auxiliary heating function(optional)
- Low voltage ride through and reactive power compensation function(optional).
- Coordinate with Kehua's anti-countercurrent system and use in grid-connected self-used project.

## 2.1.2 Nameplate

The important information of the product can be obtained on the nameplate, as shown in Figure2-2.



	
Name: PV grid-interactive inverter	
Model: SPI500K-B	
DC voltage range:	DC 460-1000V
Max DC short current (Isc):	DC 1418.8A
MPPT voltage range:	DC 460-850V
Max DC input current:	DC 1200A
Rated grid voltage:	AC 315V,3~/PE
Rated grid frequency:	50Hz
Max output current:	AC 1008A
Rated capacity:	500kW
Power factor(full load):	>0.99
Protective class:	I
Ingress protection rating:	IP20
	
PRODUCED BY: Xiamen Kehua Hengsheng CO.,LTD.(CHINA) www.kehua.com	

Figure2-2 SPI500K-B (V4.1~V4.3)nameplate information

## 2.1.3 Product Difference

The product difference of SPI500K-B(V4.1-4.3) is as shown in Table2-1.

Table2-1 The product difference ofSPI500K-B(V4.1-4.3)

Model	Difference
SPI500K-B V4.1	DC input is 1 route disconnecter.
SPI500K-B V4.2	DC input is 8 routes breaker.
SPI500K-B V4.3	DC input is 8 routes breaker with anti-reverse diode.

## 2.2 Appearance and Panel

### 2.2.1 Appearance

The appearance of SPI500K-B products is as shown in Figure2-3.

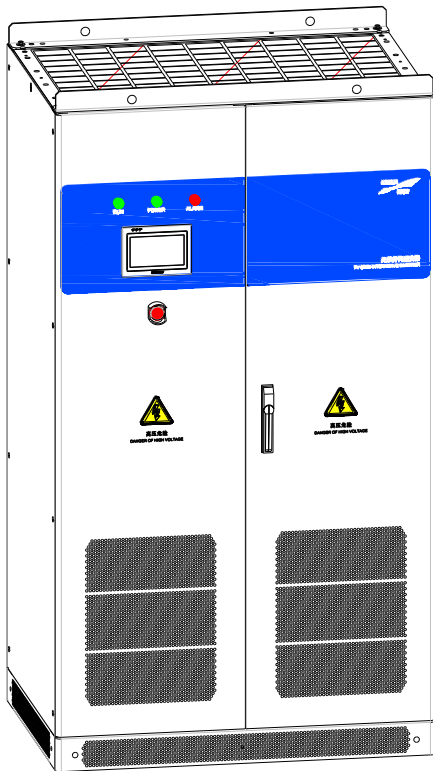

Figure2-3 Appearance

### 2.2.2 Panel

The operation panel of SPI500K-B series products is as shown in Figure2-4.

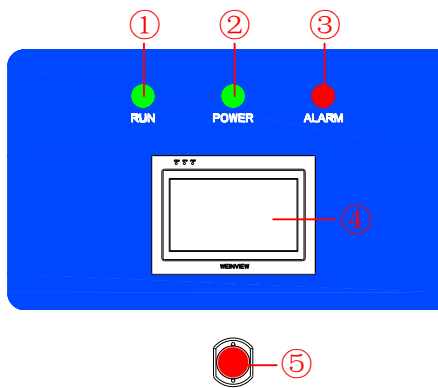

Figure2-4 Operation panel

The description of operation panel is as shown in Table2-2.

Table2-2 Description of the operation panel

NO.	Silk screen	Name	Description
○,1	RUN	RUN indicator	Green: when the indicator is on, the PV grid-connected inverter is going to generate power.
○,2	POWER	POWER indicator	Green: when the indicator is on, the power supply of control power is normal.
○,3	ALARM	ALARM indicator	Red: when the indicator is on, the equipment is faulty, when the fault disappears, it will turn off automatic.
○,4		Display screen	Display and setting.
○,5		EPO	EPO button is used to disconnect the connection of the inverter and power grid in emergency, which ensure the safety of the inverter. Be sure to spin off the EPO button before the system restart.



## CAUTION

After using EPO button, if you want to recover grid-connected, user need to popup the EPO and reboot the control power.

## 2.3 Component Description

### 2.3.1 DC Disconnecter

DC disconnecter is the connector between PV grid-connected inverter and PV modules. When the equipment is working properly, the DC disconnecter must stay in “ON” position. When operating and wiring, keep the DC disconnecter stay in “OFF” position. When maintenance, place the DC disconnecter stay in “OFF” position and wait for 20 minutes, and measure that the DC busbar voltage inside the device should be under 10 V, then the maintenance can be done.



#### CAUTION

Before maintenance or wiring, it is necessary to disconnect the DC disconnecter.

---

### 2.3.2 AC Disconnecter

AC disconnecter is the connector between PV grid-connected inverter and power grid. Keep the disconnecter stay in “ON” position when the equipment is working properly.

Be sure to switch off the AC disconnecter under below situations.

- Before wiring, disconnect the AC disconnecter.
- Before maintenance, switch off AC disconnecter and wait for 20 minutes to avoid electric shock.
- If it needs to recover grid-connection after pressing EPO, switch off the AC disconnecter and the DC disconnecter and then switch them on again after disconnecting the power of the inverter.

### 2.3.3 Fuse of DC Side and AC Side

The fuse of DC side is the protection for solar battery plate and PV grid-connected inverter (the product of V4.1 version has the fuse only, other versions is 8 routes breaker). The fuse of AC side is the protection of PV grid-connected inverter and power grid. When some serious faults occur, the fuse will fuse to ensure the separation of solar battery plate and PV grid-connected inverter, power grid and PV grid-connected inverter.

If the fuse is damaged and needs to replace, it must accord with the requirements shown in Table2-3.

Table2-3 Requirement of fuse

Position	Fuse of AC side
Rated voltage	690V
Rated current	1600A
Recommended model and brand	170M6469 / Bussmann

## 2.4 Work Principle

The electricity produced by PV modules goes through SPD and DC filter. The SPD absorb DC side surge voltage, and DC filter restrain high-frequency signal conduction interference, and keep the DC voltage stable with storage capacitor, Three phase full bridge inverter unit will convert DC to AC of the same frequency and phase with power grid, and produce sine wave AC through filtering, and then AC filter suppressing conducted interference from high frequency signal, the electricity will be delivered to the grid by befitting transformer.

The product difference of SPI500K-B(V4.1-4.3) is as shown in Table2-1The working principle of the V4.3inverter is as shown in Figure2-5.



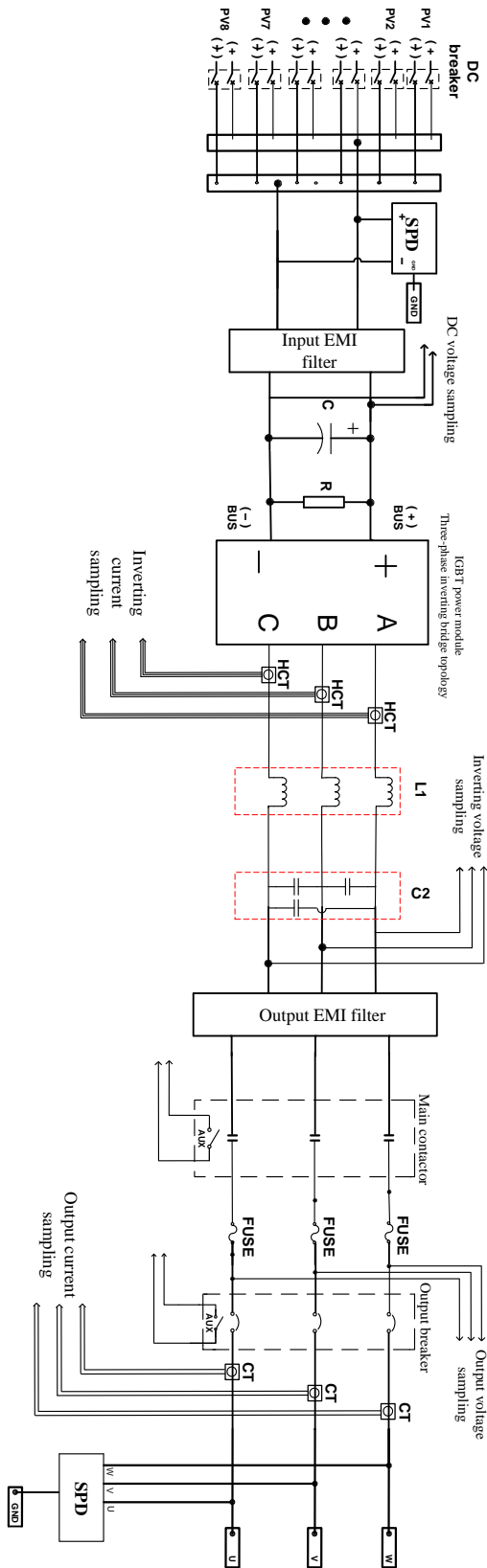

Figure2-5 Work principle diagram of V4.3 product

## 2.5 Working Modes

The inverter can realize nobody monitoring and automatic working. System will determine whether to connect grid and generate power according to the output power of PV array. The system running process includes start, connect grid and generation, standby, normal halt and fault dispose.

Modes conversion procedure of the inverter is as shown in Figure2-6.

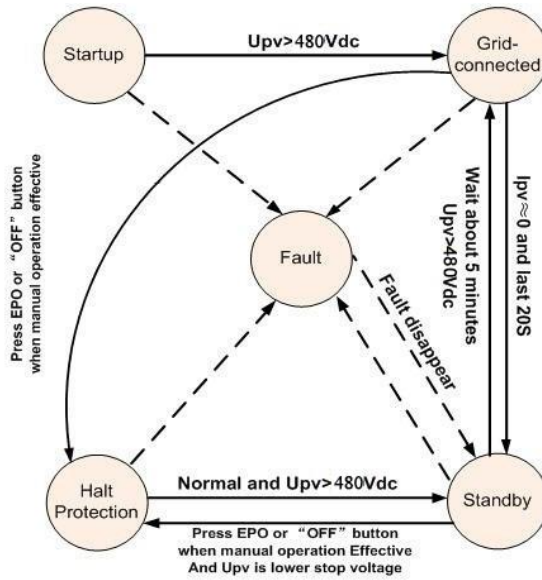

Figure2-6 Modes conversion procedure



### NOTE

Upv is PV array DC output voltage, and Ipv is PV array DC output current.

### Startup

The startup mode is the preparation stage from machine halt mode to grid-connected generation mode. In this mode, the grid-connected inverter continually detects whether the PV module has enough energy to grid-connected generation, if the open-circuit voltage of PV module is up to 480V, it will switch to grid-connected generation mode from startup mode.

### Grid-connected generation

Grid-connected generation means that the inverter converts the DC power of PV array into AC power and deliver to grid. In order to output the maximum power as far as possible, system adopts the maximum power point tracking (MPPT) control mode, it is said that no matter in any sunlight and temperature, the solar battery arrays output the maximum power.

## Standby

Standby means that the output voltage of PV array up to a certain value and the parameters of grid voltage and frequency are within normal range, and the grid-connected contactor is connected, but the output energy of PV array is not enough to generate power continuously. In this mode, the inverter generates power per 5 minutes, when PV array detects that there have enough energy to meet the condition of continuous grid-connected power generation; the inverter will maintain grid-connected.

## Halt protection

When light intensity decreases, the array output power decreases too. When the array power is low, the device will enter standby mode firstly. When the open circuit voltage of PV array is less than the shutdown voltage for 5 minutes, grid side contactor will disconnect from the grid. If the shutdown is because of clicking stop button in manual mode, need to click "RUN" button to reconnect.

## Fault

When system detects a fault, if system is in grid-connected mode, it should stop and disconnect immediately, in this status, the alarm indicator is steady on, the buzzer is buzzing, LCD display fault, and user can dispose according to current fault and troubleshooting table. After 5 minutes, the system will automatically detect whether it meets the condition of grid-connected. If the conditions are met, it starts to generate power normally, otherwise the fault status will maintain until the system recovers.

## 2.6 Monitoring Mode

The inverter has various monitoring modes, user can easily obtain the current operation data of the inverter. There are two monitoring modes as follows.

### 2.6.1 Monitor by RS485 Information Collector

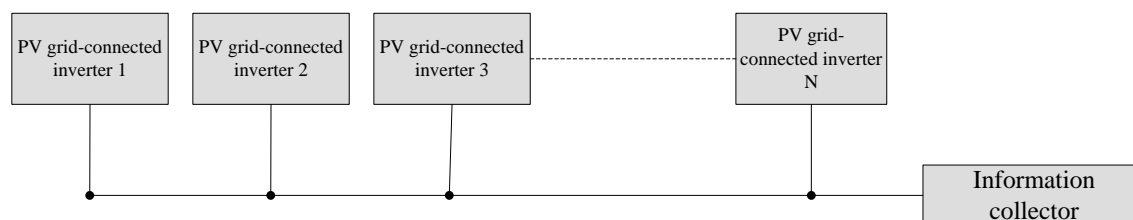

Figure2-7 Monitoring by RS485 information collector

## 2.6.2 Computer Monitor by RS485

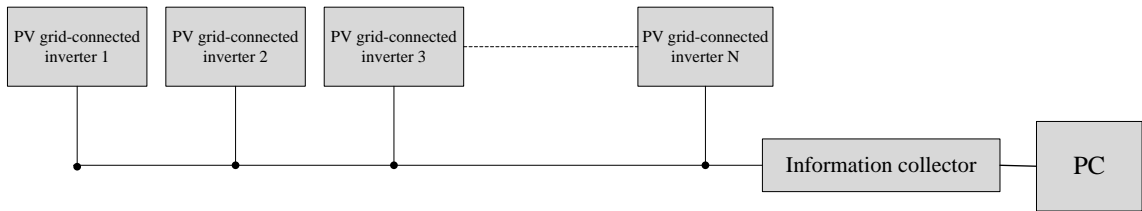

Figure2-8 Computer monitor by RS485

When monitoring PV grid-connected inverter by PC, the communication adopts RS485 bus, and there is a RS485/RS232 electrical level converter between PC and RS485, the communication system wiring is as shown in Figure2-9.

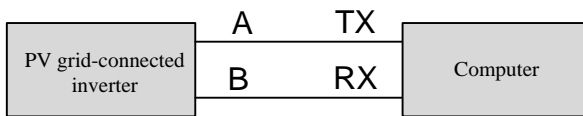

Figure2-9 connection between the inverter and PC

The RS485 port position of the inverter is as shown in Figure2-10.

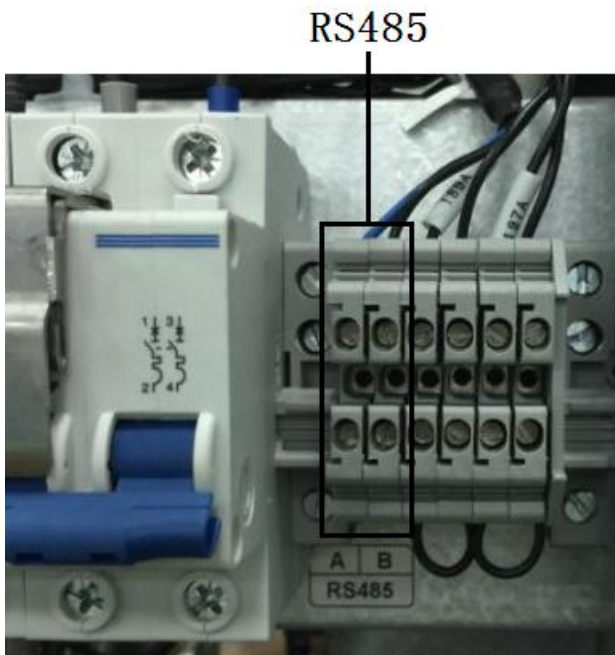

Figure2-10 Position of RS485 port

## 3 Installation

This chapter mainly introduces the installation of the inverter, including the preparation before installing, the requirements for installing environment, installation of the inverter, electrical connection, etc.



### 3.1 Unpacking and Checking













Unpacking the inverter and conduct the following checks:









- Inspect the solar inverter appearance for shipping damage, if any shipping damage is found, report it to the carrier and your local dealer immediately.
- Check the delivery list to see if the types of the accessories are complete and correct. If there is any discrepancy, contact the distributor immediately.

### 3.2 Installation Preparation

#### 3.2.1 Tools

Tool	Appearance	Description
Clamp-on ammeter		Measure current
Multimeter		Used to check cabinet insulation and cable connection, and measure electronic performance specifications of a device, such as voltage, current, and resistance.
Label paper		Used to prepare labels.

Tool	Appearance	Description
Phillips screwdriver (PH2x 150mm and PH3 x250mm)		Used to tighten screws and bolts.
Slotted screwdriver (2mm× 80mm)		Connect cable, fasten screw
Socket wrench		Used to tighten bolts and nuts.
Adjustable spanner		Fasten bolt
Torque wrench		Fasten bolt
COAX crimping tool		Used to crimp cord end terminals.
Diagonal pliers		Used to cut insulation cables and cable ties.
Wire stripper		Used to remove the insulation layer and jacket from a communication cable with a small cross-sectional area.
Claw hammer		Beat, install, and disassemble component.
Impact drill, drill (Φ14)		Drilling
PVC insulation tape		Used to insulate wires and conductors.
Cotton cloth		Used to clean panels and shells.

Tool	Appearance	Description
Brush		Clean the panel and shell.
Heat shrink tubing (Φ14、Φ18、Φ20、Φ25)		Used to insulate wires and conductors.
Heat gun		Used to heat a heat shrink tubing.
Electrician's knife		Used to strip cables.
Protective gloves		Used to protect hands and the device on which you operate.
ESD gloves		Used to prevent the electrostatic discharge (ESD) from damaging a board or other electrostatic sensitive devices (ESSDs) when you insert or remove a board or hold an ESSD.
Insulated gloves		Used to insulate hands.
Hydraulic pliers		Used to crimp the OT terminals and JG terminals with a large cross-sectional area of 10 mm <sup>2</sup> , 16 mm <sup>2</sup> , 25 mm <sup>2</sup> , or 35 mm <sup>2</sup> .
Cable tie		Used to bind cables.

### 3.2.2 Installation Environment

- The equipment is indoor inverter and meets IP20 protection grade. Install the equipment in an environment with good ventilation and free of dust.
- Foundation should ensure stable and safe of the installation position.
- According to EMC and noise grade, the equipment is used for industry environment, so the installation position should far away living quarters.

- The temperature should be within the range of  $-25^{\circ}\text{C}$  and  $+45^{\circ}\text{C}$ .

### 3.2.3 Installation Clearance

- The dimension of the inverter is  $1100\text{mm} \times 2000\text{mm} \times 800\text{mm}$  (W×H×D), and the weight is 1000kg. Keep enough space to install the inverter. So, the foundation must have a certain load bearing capacity to support the inverter and enough space to place the inverter. Please put the inverter on the foundation on the basis of the inverter's size, as shown in Figure3-1.
- The space requirement for inverter installation is as shown in Table3-1. If allowable, it is recommended to keep a bigger space between the inverter and adjacent device or wall, which is to ensure stable and high efficient running of the inverter.
- When the inverter is used in parallel system, the space of whole equipment after paralleled should meet the requirement in Table3-1.

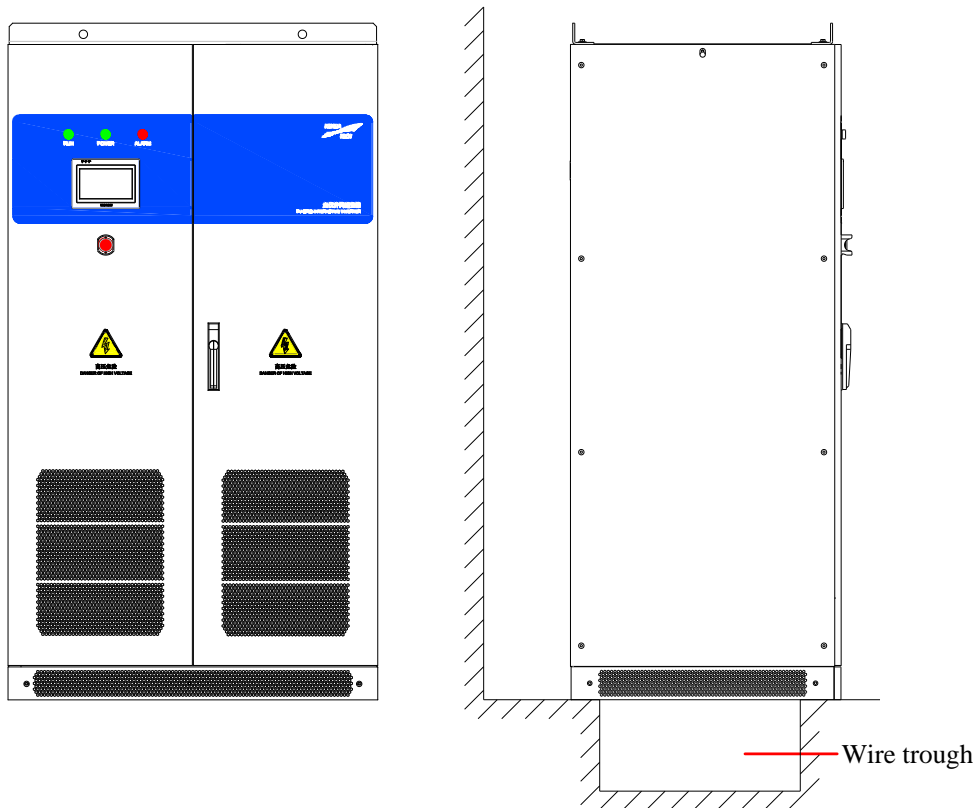

Figure3-1 Wire trough



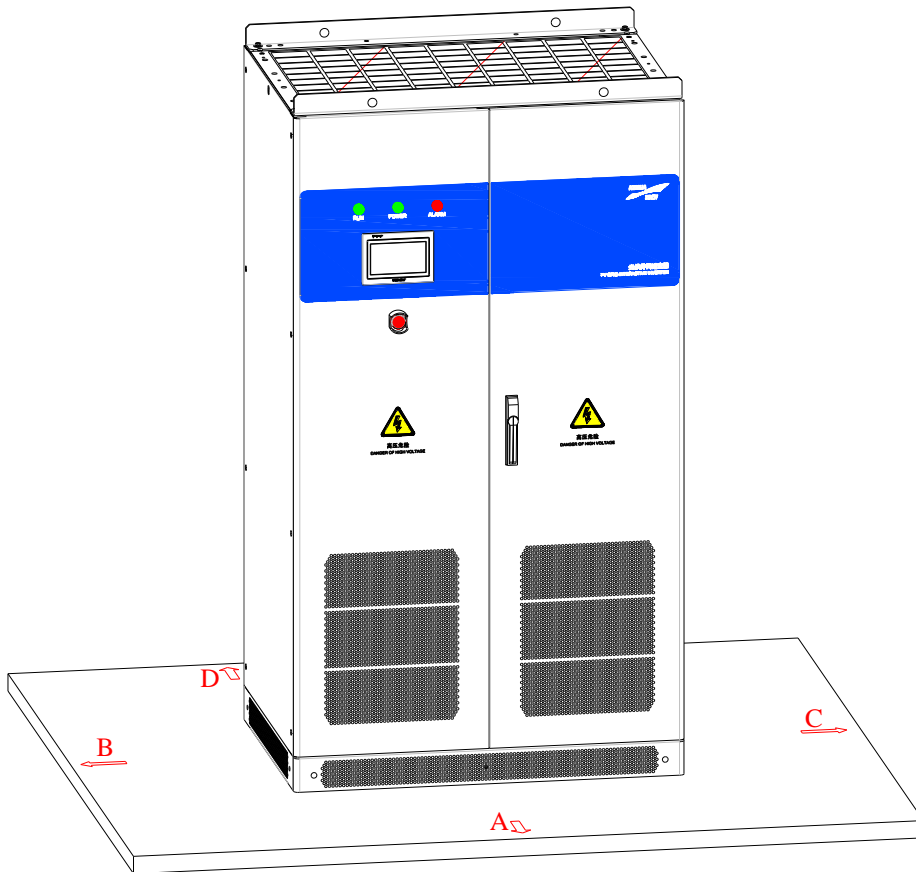

Figure3-2 Installation space diagram

Table3-1 The min. installation space size (mm)

A	B	C	D	E
1300	600	600	700	500

### 3.2.4 Heat Dissipation Requirements for Installing Environment

To ensure the inverter work in good status, the installation space should be with good ventilation.

If the installation environment is closed space, it is necessary to use heat dissipation air flue to discharge the heat generated by the inverter out of the room, which is to ensure the indoor temperature meets the normal operation requirements (as shown in Figure3-3).

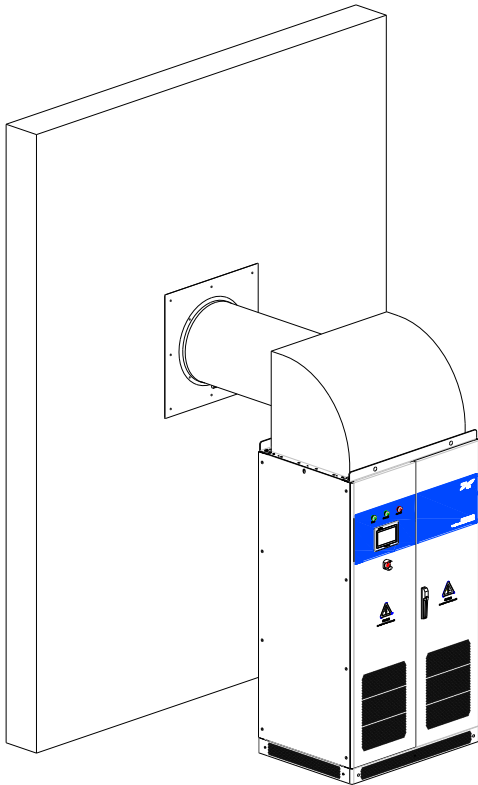

Figure3-3 Air flue diagram for heat dissipation



### CAUTION

Please clean the dust and barrier on the air outlet regularly (every 3 months).

---



### CAUTION

The heat dissipation air flue should be designed by professionals. When using heat dissipation air flue, the size of E in Table3-1 should be adjusted according to the actual size of air flue.

---

## 3.3 Transportation

### 3.3.1 Forklift Transportation

The inverter can be transported by forklift, as shown in Figure3-4. During transport the inverter by forklift, it is necessary to keep the center of gravity in the centre of the two forks, and the transportation process should be slow and steady.



Figure3-4 Forklift transportation

**CAUTION**

When use forklift to lift the inverter, keep the equipment vertical, and do not put down or put up suddenly.

### 3.3.2 Lifting Transportation

The inverter can be lifting transported through the girder at the top of the inverter, as shown in Figure3-5. Before lifting, ensure that the distance between lifting hook and the top of the inverter is more than 1 meter, and the keep the transportation process slow and steady.

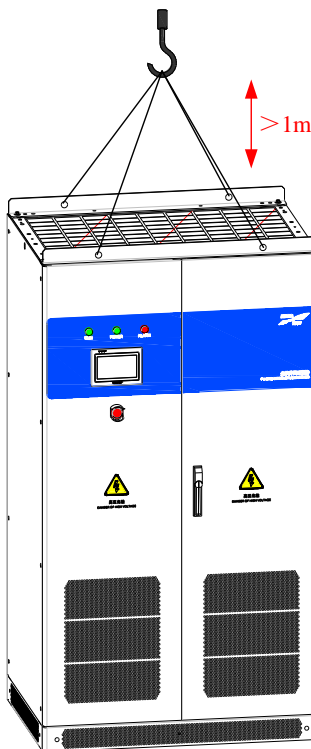

Figure3-5 Lifting transportation

## 3.4 Installation Procedure

- Step 1 Select and determine the installation position according to the inverter size (as shown in Figure3-6) and installation clearance requirements (see 3.2.3 *Installation Clearance*).

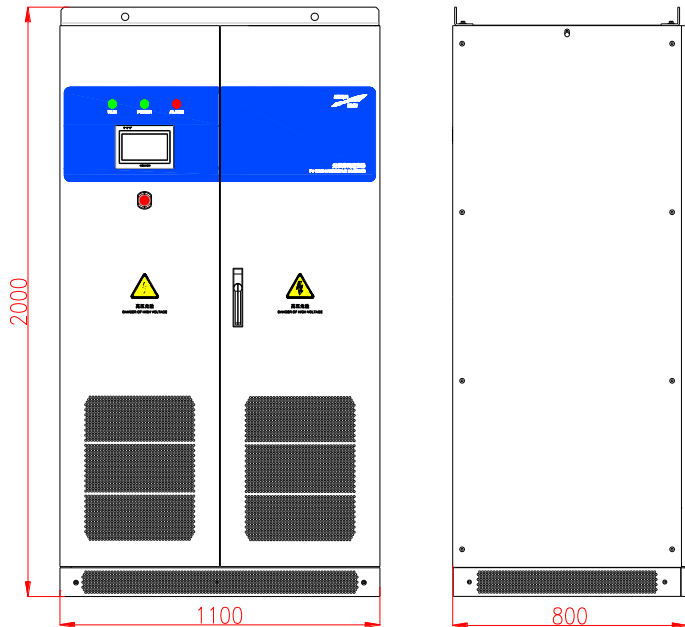

Figure3-6 The external size of the inverter

- Step 2 Install 4 pieces of M12 expansion bolts into ground according to the installation hole position diagram, as shown in Figure3-7.

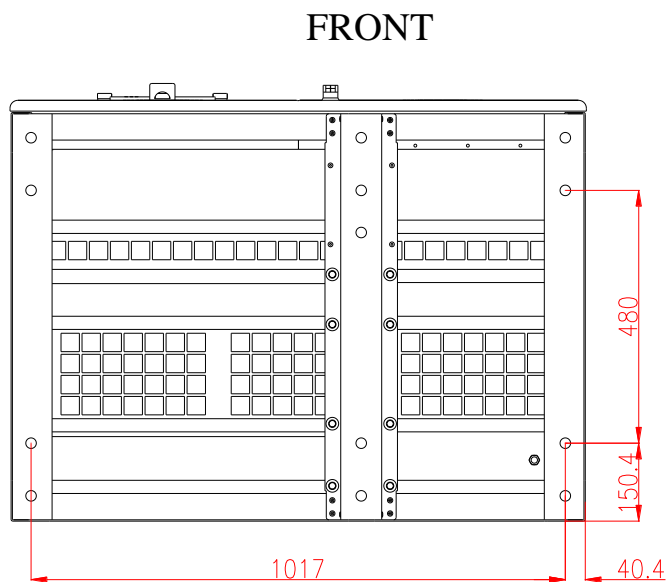

Figure3-7 Size of pedestal installing hole (bottom view)

 **NOTE**

The exposed part of expansion bolt must be within 50mm.

For convenient wire installation and maintenance, it is necessary to reserve corresponding cable trough, the schematic diagram is as shown in Figure3-7.

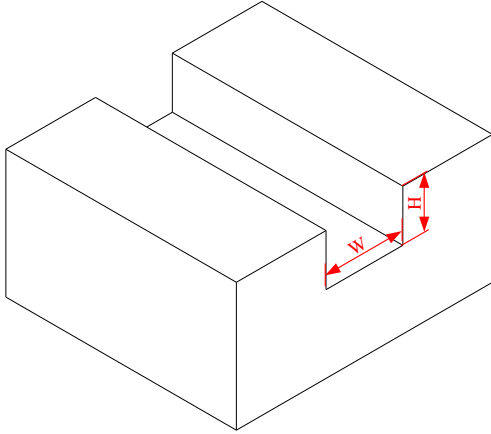

Figure3-8 Geosyncline diagram

 **NOTE**

The recommended weight and depth of cable trough is within the range of 500-600mm.

- Step 3 Transport the inverter to specified position and unpack the inverter.
- Step 4 Remove the bottom baffle at the side of the inverter, and then dismantle the 4 pieces of M12 bolts which are fastened the pedestal of the inverter and wooden bracket. The position of fastened bolts is as shown in Figure3-9.

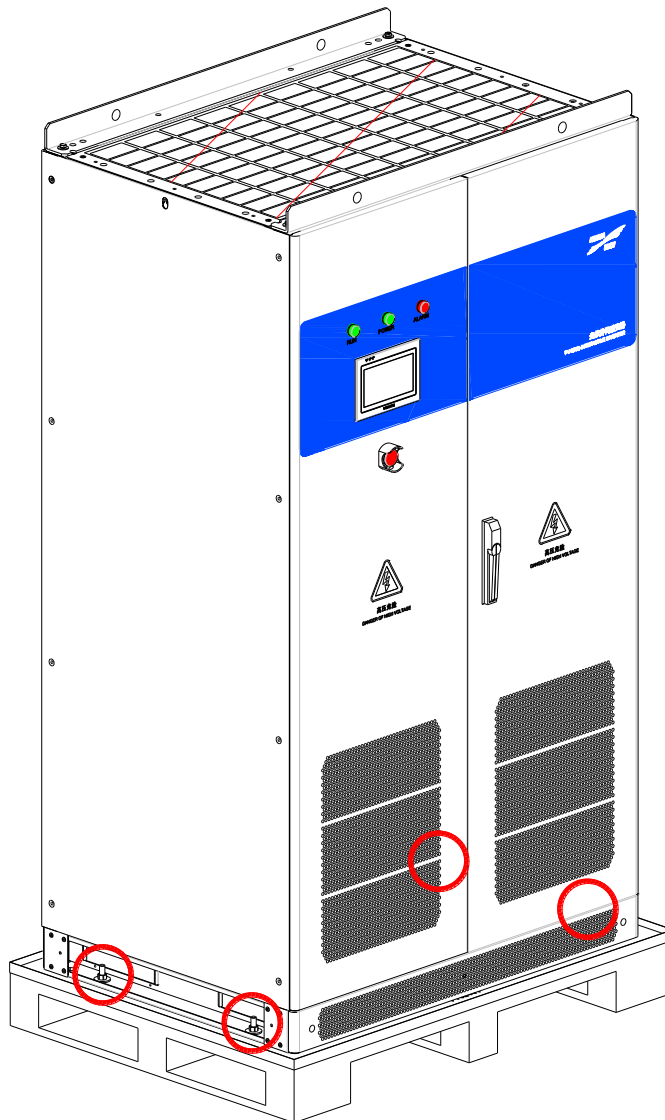

Figure3-9 The position of fastened bolts

- Step 5 Move the inverter from wooden bracket to the ground, and align the installation hole of pedestal to the position of expansion bolt, install  $\Phi 12$  flat gasket, spring gasket, then fasten them.
- Step 6 Reinstall the bottom baffle at the side of the inverter, then the installation is finished.

----End

## 3.5 Electrical Connection

### 3.5.1 Wiring Requirements



#### CAUTION

Grid-connected generation should be allowed by local power supply department and operated by professionals. Ensure that the AC&DC side is without electricity when wiring. The open-circuit voltage of configured PV array should not exceed 1000V.

Before wiring, please see the requirements of wiring, as shown in Table3-2.

Table3-2 Requirements for wiring

Wire name	The minimum wire diameter (mm <sup>2</sup> )
PV array DC+	At least 8 routes input, and the diameter of each route should be 70mm <sup>2</sup> , the rated voltage should be more than 1000V. or select other model cables, but the total wire diameter should no less than 500 mm <sup>2</sup> .
PV array DC—	At least 8 routes input, and the diameter of each route should be 70mm <sup>2</sup> , the rated voltage should be more than 1000V. Or select other model cables, but the total wire diameter should no less than 500 mm <sup>2</sup> .
Power grid phase L1	At least 4 routes input for each phase, and the diameter of each route should be 120mm <sup>2</sup> , several routes can be selected. The recommended diameter of single wire should be no more than 120mm <sup>2</sup> . Or select other model cables, but the total wire diameter of each phase should no less than 450 mm <sup>2</sup> .
Power grid phase L2	
Power grid phase L3	
Neutral wire	None
Grounding wire	The recommended diameter is more than 300mm <sup>2</sup> .
Communication wire	0.3mm <sup>2</sup> , it is recommended to use shield cables.

 **NOTE**

The dimensions of wires above are based on UL standard. If user chooses other wires, please replace reasonably referring to standard.

### 3.5.2 Wiring Procedure

Step 1 Use the keys to open the locks of the front door separately.



#### CAUTION

The front door cannot be opened when the inverter is running.



Figure3-10 Lock of front door

Step 2 Open the front door, and then dismantle two bottom cover plate with honeycomb holes of AD side and DC side. The bottom wiring of the inverter is as shown in Figure3-11. After connecting the wires of output, paint fireproofing mud to seal.

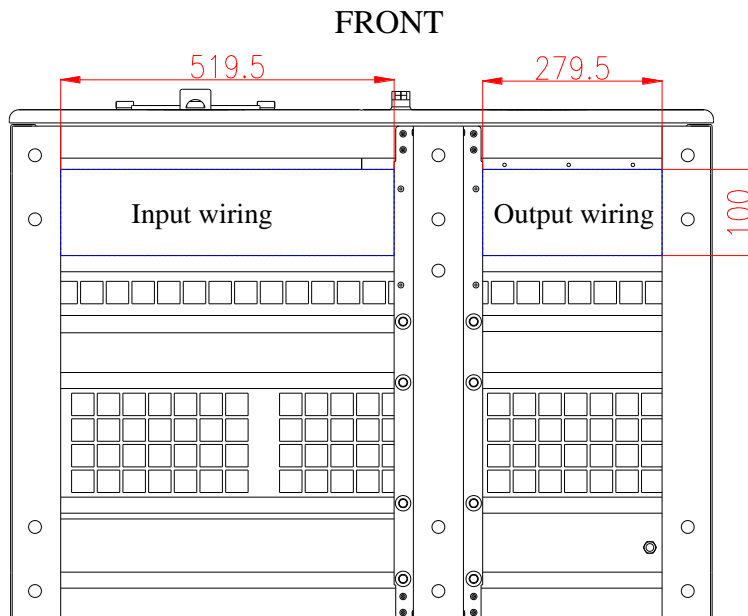

Figure3-11 Bottom wiring diagram



Step 3 Connect the grounding wires, and wiring position is as shown inFigure3-14.



### CAUTION

Ensure the grounding wire is connected to the grounding wire of the area, and ensure good connection. The grounding standard please see“Table3-2 Wiring requirements”.



### WARNING

When connecting grounding wire, make sure all grounding wires and grounding equipment are properly connected to earth, which is to avoid cabinet shell with electricity.

Step 4 Connect wires of grid side according to U(A), V(B), W(C) phase sequence from right to left.

The wiring diagram of power grid is as shown inFigure3-12.



### CAUTION

Because there exists high voltage in power grid, please ensure that the AC distributing breaker is switched off while wiring, which is to ensure the wiring terminal without electricity.

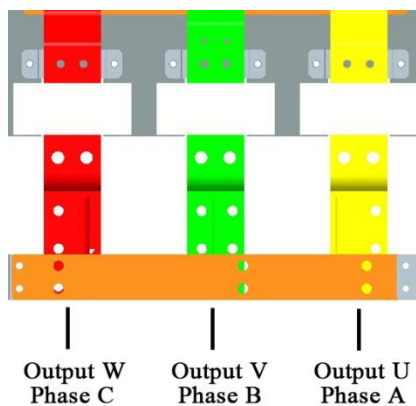

Figure3-12 Wiring diagram of power grid side



### NOTE

Connect the AC,DC and grounding wires from bottom of inverter, It is recommended that adopts through geosyncline to connect wires.

The inverter is without transformer, the output voltage is 315V (line voltage), It's recommended to select suitable transformer on the basis of practical use to grid-connected. It's recommended to use Dyn11 connection (adopt D-type connection way at inverter side, and Y-type connection way at the grid side, as shown inFigure3-13). Transformer installation should be close to the inverter as far as possible, and pay attention to the heat dissipation treatment of the transformer.

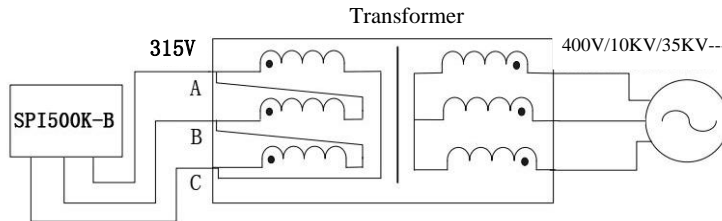

Figure3-13 Wiring diagram of Transformer



**CAUTION**

User should select suitable transformer based on practical application to connect grid.

Step 5 Connect wires of DC side.

The anode and cathode of PV array is connected to “+” and “-” of DC input separately, the DC side wiring of SPI500K-B V4.2, V4.3 is as shown inFigure3-14.

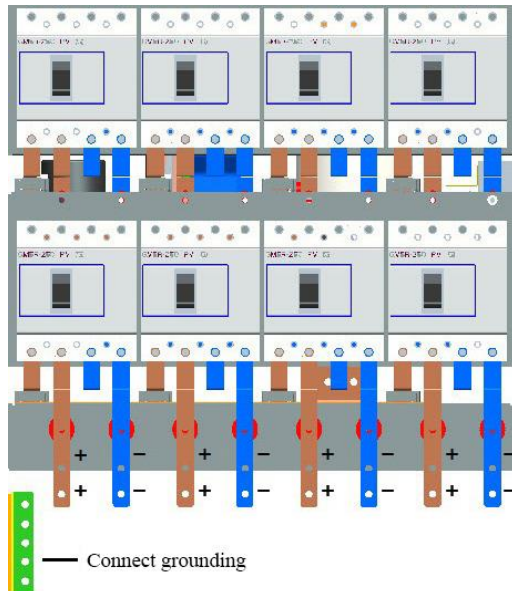

Figure3-14 Wiring diagram of DC side

**CAUTION**

When connecting the wires of DC side input, the input current should not exceed 1200A (the current of each route in V4.2-V4.3 products, should not exceed 160A).

---

----End

## 4 Operation Guide

This chapter mainly introduces the touch screen operation of SPI500K-B(V4.1-V4.3), including the function of touch screen, menu structure, main interface, startup and shutdown, setting, etc.

### 4.1 Function of Touch Screen

It can realize following functions by touch screen, as shown in Table4-1.

Table4-1 The function of touch screen

No.	Function Description
1	Look up the current operation parameters.
2	Look up and change operation mode.
3	Look up the current and history faults.
4	Look up and change the current time.

## 4.2 Menu Structure of LCD Touch Screen

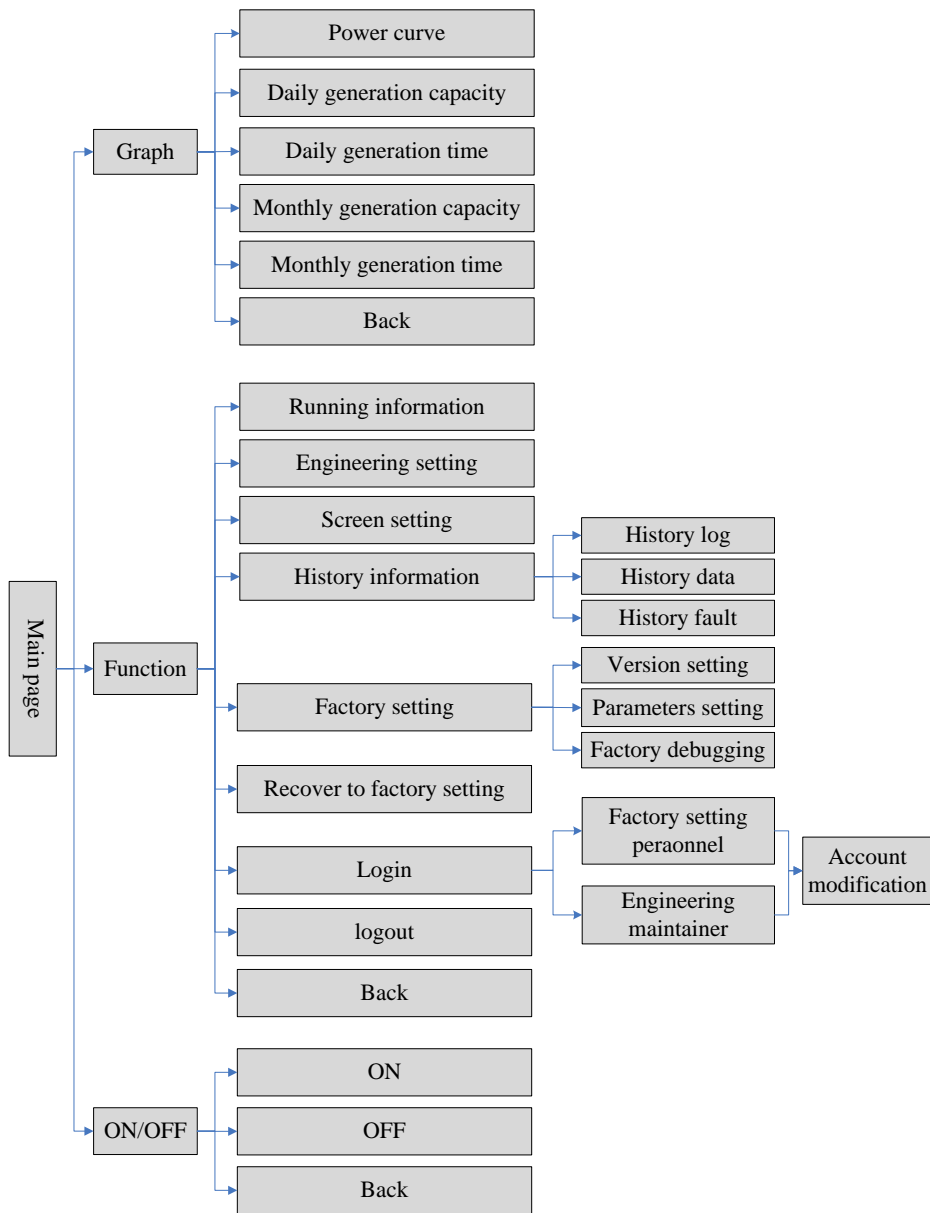

Figure4-1 Menu structure

- Main page: look up graphs and functions, perform ON/OFF operation.
  - The graph includes power curve, daily generation capacity, daily generation time, monthly Generation capacity and monthly generation time.
  - The function: look up and set system information.
  - ON/OFF operation: it is used to start and stop the equipment.
- Login: Different personnel have different authority of setting and alteration.

- Running information display: Display all current measuring data and running status.
- Engineering setting: Mainly includes the site setting, power station mode, anti-countercurrent function, CVT / MPPT mode and Active islanding permission.
- Screen setting: User can set date, time, backlight brightness, screensaver and language.
- It can look up the use rate, remainder space of screen and U disk.
- History Information: Inquire and eliminate history log, history data and history fault.
- Recover to factory setting: It is used to recover the parameters of factory setting.

### 4.3 Main Page

Step 1 The main page will enter initialization page after power on, as shown in Figure4-2.



Figure4-2 Initialization page

Step 2 It will enter default main page 2 minutes later. Then it can monitor the system conveniently. The main page is as shown in Figure4-3.



Figure4-3 Default main page

The function description of default page is as follows.

- Working status: it is used to display current working status. As shown in Table4-2.

Table4-2 Working status description

Working status	Display	Description
Running	Running	Grid-connected properly
Standby	Standby	Stop grid-connected
Fault	Fault	Appear Fault, click the current fault to display fault content

- Output power: Current output of the inverter.
- Daily energy: The daily accumulated power generating capacity.
- Gross energy: The accumulated total capacity of the inverter.
- CO<sub>2</sub>emission reduction: Corresponding CO<sub>2</sub> reduction capacity of total generation capacity.

----End

## 4.4 Login

Step 1 Enter the default main page.



Step 2 Click “” icon to enter **User Login** page, as shown inFigure4-4.



Figure4-4 “User Login” page

Step 3 Enter password and click “ENT” button, then click “Login” icon, as shown in Figure4-5.



Figure4-5 Enter password page

 **NOTE**

Initial password for user is 111.

Step 4 After login, it will enter authority personnel page, as shown inFigure4-6.





Figure4-6 Authority personnel page

----End

## 4.5 ON/OFF Operation

### 4.5.1 ON Operation



- Step 1 Enter main page, click  icon, it will enter ON/OFF controlling page.
- Step 2 Click “OK” button to start the inverter, click “Cancel” button to give up the startup operation, as shown in Figure4-7.



Figure4-7 Startup page

----End

## 4.5.2 OFF Operation

- Step 1 Enter main page, click  icon, it will enter ON/OFF controlling page.
- Step 2 Click “OK” button to shut down the inverter, click “Cancel” button to give up the shutdown operation
- End

## 4.6 Running Parameters Display

Under running parameters display menu, the present running software version, electrical data, running status, etc. information can be obtained.

### 4.6.1 Look Up Operation Procedure

- Step 1 Enter the default main page.
- Step 2 Click  icon to enter **Function** page, as shown in Figure4-8.

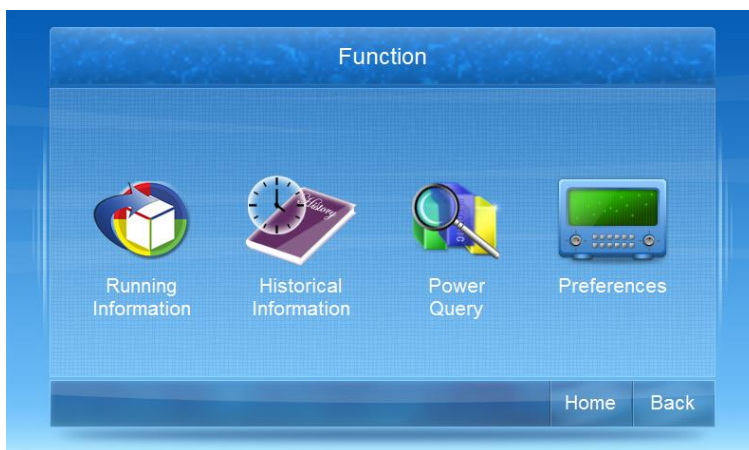

Figure4-8 Function page

- Step 3 Click “running information” icon to enter **Running Information** page, as shown in Figure4-9 and Figure4-10.



Running Information					
UV Grid Voltage	0.0	V	Frequency	0.00	Hz
VW Grid Voltage	0.0	V	Inside Temp.	0.0	°C
WU Grid Voltage	0.0	V	Radiator Temp.	0.0	°C
U Phase Grid Current	0.0	A	Input Power	0.0	kW
V Phase Grid Current	0.0	A	Output Apparent Power	0.0	kVA
W Phase Grid Current	0.0	A	Output Active Power	0.0	kW
PV Voltage	0.0	V	Output Reactive Power	0.0	kvar
PV Current	0.0	A			

Next Home Back

Figure4-9 “Running information” page

Step 4 Click “Next” button to look up the information in next page.



Running Information					
UV Inv.Voltage	0.0	V	U Phase DC Component	0.0	A
VW Inv.Voltage	0.0	V	V Phase DC Component	0.0	A
WU Inv.Voltage	0.0	V	W Phase DC Component	0.0	A
U Inv. Current	0.0	A	Isolation Voltage	0.0	V
V Inv. Current	0.0	A	Total Running Time	0.0	h
W Inv. Current	0.0	A			

Prev. Home Back

Figure4-10 “Running information” page

----End

## 4.7 Preferences

Step 1 Enter the default main page.

Step 2 Click  icon to enter **Function** page.

Step 3 Click “preferences” icon to enter **Preferences** page, as shown in Figure4-11.



Figure4-11 “Parameters setting” page

Step 4 Click “screen setting” icon to enter **Screen Setting** page, as shown in Figure4-12.

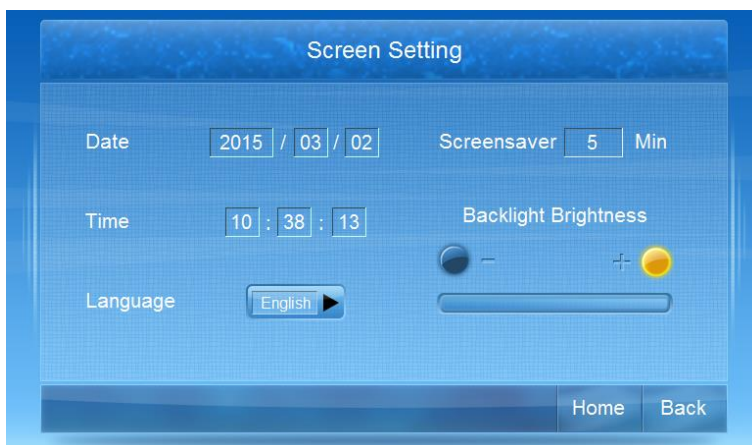

Figure4-12 “Screen setting” page

Step 5 User can set the date, time, backlight brightness, screensaver and language. After modification, it will popup a page, as shown in Figure4-13, press “OK” to confirm to modify, then modify the parameters, and press OK to confirm the modification, as shown in Figure4-14.

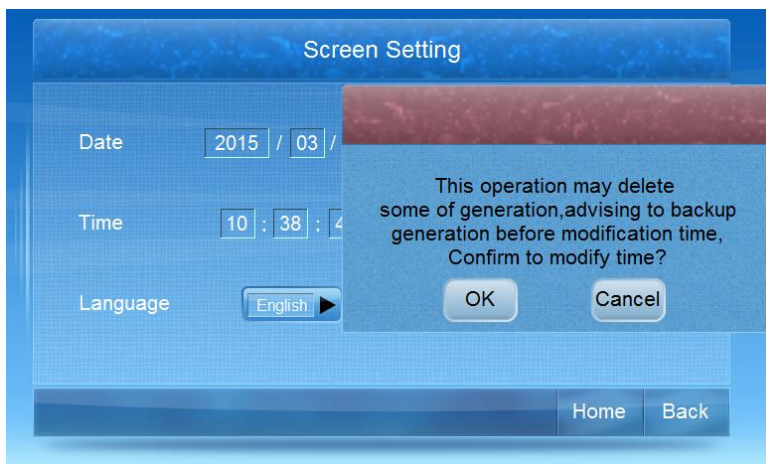

Figure4-13 Screen setting modification page



Figure4-14 Date and time setting

----End

## 4.8 Engineering Setting

Step 1 Enter the default main page.

Step 2 Click  icon to enter **Function** page.

Step 3 Click “preferences” icon to enter **Preferences** page, as shown inFigure4-15.



Figure4-15 Preferences page

Step 4 On **Preferences** page, click “system setting” icon to enter **System Setting** page, as shown in Figure4-16.

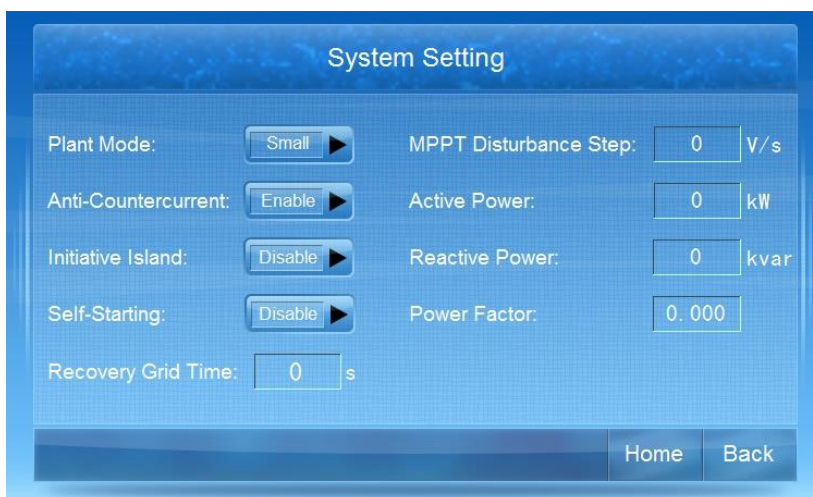

Figure4-16 “System setting” page

Step 5 Set the mode of power station, anti-countercurrent function, active islanding and recover time of grid-connected, etc.

- Plant mode: set as big power station.
- Anti-countercurrent: set as disable.
- Initiative island: set as enable.
- Self-starting: set as enable.
- Recovery grid time: 20s.
- MPPT disturbance step: set as 4V/S.

- Active power: 500KW.
- Reactive power: 0 Kvar.
- Power factor: set as 1.

----End

## 4.9 NowFault Inquiry

Step 1 If the system occurs some faults, the touch screen will popup “alarm” window, as shown inFigure4-17.



Figure4-17 Alarm window



Step 2 Click “” icon, it will enter **Now Fault** page, as shown in Figure4-18.



Figure4-18 “Now fault” page

Step 3 Click “back” button to return to upper page.

----End

## 4.10 History Information

Under the system running status, if user needs to inquire the history information of the inverter, perform the following procedures.

Step 1 Enter the default main page.



Step 2 Click icon to enter **Function** page.

Step 3 Click “historical information” icon to enter **Historical Information** page, as shown in Figure4-19.

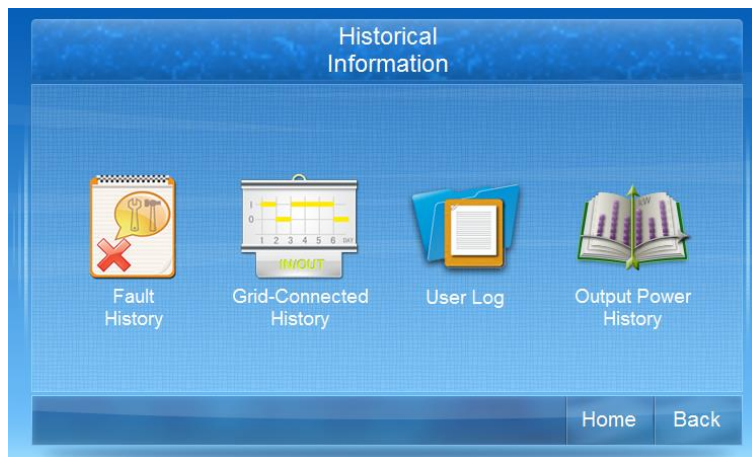

Figure4-19 “History information” page

Step 4 Click “user log”, “grid-connected history” or “fault history” and “output power history” icon to enter history data page. When entering the corresponding history data page, the history data can be looked up and cleaned.

----End

## 4.11 Recover to Factory Setting

Step 1 Enter the default main page.



Step 2 Click icon to enter **Function** page.

Step 3 Click “preference” icon to **Preferences** page.



Step 4 Click “restore to factory setting” icon to enter recover to factory setting page, as shown in Figure 4-20.



Figure 4-20 Recover to factory setting page

Step 5 After clicking “OK”, it will perform the operation of restore to factory setting, as shown in Figure 4-21.

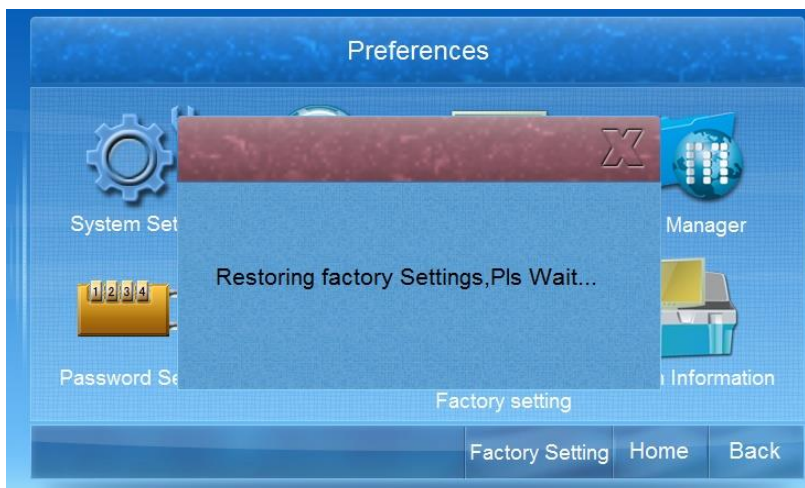

Figure 4-21 Perform “recover to factory setting”

----End

# 5 System Commissioning

This chapter mainly introduces the system commissioning of the inverter, including manual operation and automatic operation.

## 5.1 Manual Operation



### CAUTION

Please re-confirm DC&AC voltage according with allowable range of the inverter, switch on DC circuit breaker of the inverter first, and then switch on DC circuit breakers of the distribution box, otherwise the device may damage.

---



### NOTE

After commissioning, set “System setting\Self-starting” to enable, to ensure that the inverter will automatically operate unattended when meeting the conditions.

### 5.1.1 Check Before Operating

- Confirm that the cable connection between inverter and grid is correct.
- Confirm that the polarity of PV array is correct.
- Confirm that the AC and DC wiring terminals are fastened.

### 5.1.2 Startup Procedure

After checking, start the inverter in following steps.

Step 1 Close the surge protection breaker of DC side (K1), as shown in Figure5-1.

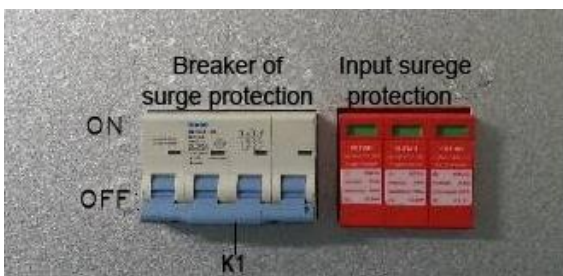

Figure5-1 Step 1

Step 2 Close the surge protection breaker of AC side (K2), as shown in Figure5-2.

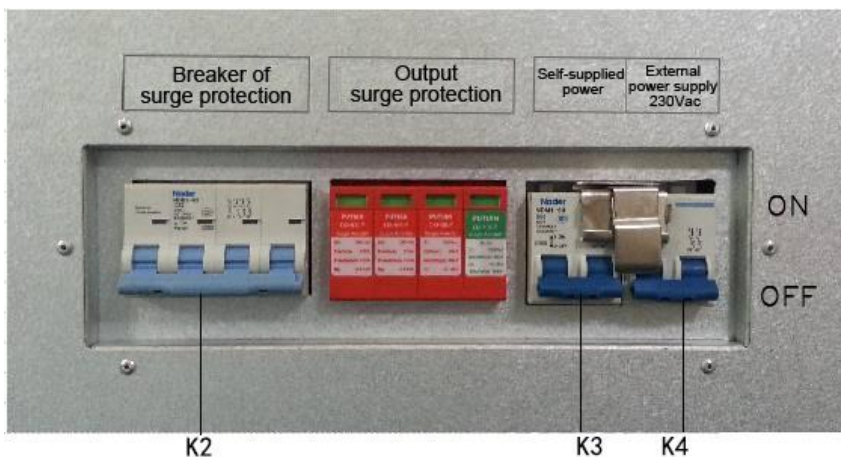

Figure5-2 Step 2

Step 3 Close the breaker of auxiliary power (K3), as shown in Figure5-3.

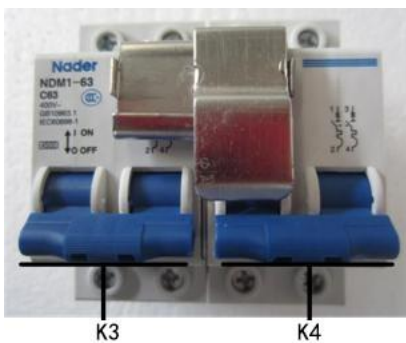

Figure5-3 Step 3

**NOTE**

K3 is internal self-power supply, K4 is power supplied by external 230Vac, the two breakers cannot be closed at the same time.

Step 4 Close the disconnecter CB1 of the AC side and then close all the breakers of the DC side.

Step 5 Close the door of the inverter, close LK1 and ensure the door is closed, as shown in the Figure5-4.



Figure5-4 Step 5

- Step 6 Close the AC breaker of AC distribution cabinet
- Step 7 Set the “system setting \self-starting” to disable.
- Step 8 Close the breaker of DC distribution cabinet.
- Step 9 Close the DC breakers of junction box successively.

**---End**

After completing above steps, if the power grid is normal and the voltage of DC side is more than 480V, click “ON” button to start the inverter.

 **NOTE**

The handle of AC side is located in the middle inner holder of left door. After operation, please put it back and fix well.

## 5.2 Self-starting

Follow the steps above, press the OFF button on the touch screen, set the “System setting\self-starting” as enable. After finishing the steps above, the inverter will run automatically once meet the grid-connected conditions.

## 6 Routine Maintenance

This chapter mainly introduces the maintenance and safety precautions, preventive maintenance and maintenance procedure, etc.

### 6.1 Machine Room Management

Room management include room environment security management and device management .The job of room environment security management is to keep the room temperature, humidity, cleanliness, static, noise, EMI meet the requirement ,and to ensure power supply properly. The requirement of device management is to keep mechanical properties intact, electric properties meet a criterion, device operation steady and data complete. The maintenance checking items are showed inTable6-1 (only for reference).

Table6-1 Checking items

NO.	Checking items	Cycle
1	Temperature and humidity	Daily
2	Cleanliness of control room and other rooms	Daily
3	Cleanliness of cabinet and platform surface	weekly
4	Performance of temperature and humidity alarm	weekly
5	Air condition filter clean and replacement	Monthly
6	Resistance measuringof anti-static staging, ground, seat and wrist strap.	Monthly
7	SPD (before thunderstorm season)	Season
8	Fixed gas extinguishing device	Yearly
9	Inflammable gas alarm	Yearly
10	Smoke detector and heat detector and auto alarm device	Yearly

NO.	Checking items	Cycle
11	Grounding and ground connection resistance test	Yearly
12	Dust grain density measuring	Yearly

## 6.2 Maintenance Guide

The correct maintenance is the key of the best operation for inverter. It can prolong the device service life. Maintenance includes preventive maintenance and remediation maintenance.

- Preventive maintenance includes performing some procedures that used to prevent fault and increase efficiency.
- Remediation maintenance includes looking up power systematic fault to make the maintenance effective.

## 6.3 Safety Precautions

To ensure human safety and equipment security, observe the following precautions when maintaining the equipment.

- Please keep in mind that even if the inverter is not running, there still may exist dangerous voltage. Before maintaining the equipment, wait for about 20 minutes for discharging and use a multimeter to check the voltage and make sure that the equipment is completely shut down.
- Before operating equipment, take off metal articles, such as rings, necklaces, and watches.
- Obey safety regulations strictly. For any questions, consult professionals.

## 6.4 Preventive Maintenance

To improve the operate efficiency and reliability of the equipment; perform the following maintenance tasks on a quarterly basis.

- Keep the environment clean.
- Check whether the wiring terminals on input, output cables are in good connection.
- Check whether fans work properly and the air vents are not blocked. If a fan is damaged, replace it in time.
- Check the equipment status periodically.

## 6.5 Maintenance Operation Procedure

- Step 1 Shut down the inverter according to “ON/OFF” operation on the panel (at this time, the inverter does not grid-connected generation, but the input and output port of the inverter still has electricity).
- Step 2 Switch off all input and output disconnectors which are connected to inverter.



### CAUTION

The capacitance inside the inverter has some residual charge which is dangerous, wait for enough time ( $\geq 20$  minutes) to release charge completely before operation.

---

- Step 3 Dismantle the cables of DC input, AC output and grounding wire connected with rack by screwdriver or other tools, and wrap the wire joint by insulation tape to prevent short circuit.



### CAUTION

Confirm front end breakers of DC input and AC output are disconnected before dismantling DC input and AC output wires.

---

- Step 4 Dismantle the fixed screws of the panel, and then perform the maintenance or replacement.
- Step 5 After finishing maintenance, reinstall the inverter panel by screws, then connect the DC input & output wires, switch on AC output breaker, then switch on DC input breaker and reset the startup operation.

---- **End**

# 7 Troubleshooting

This chapter mainly introduces the dispose methods of common faults.

## 7.1 Rectifying Common Faults

Once the inverter failure, the fault indicator will be on, buzzer will send alarm, and the touch screen will display the current fault, at the same time, the inverter will halt. The typical fault and solution is as shown in Table7-1.

Table7-1 Troubleshooting

Phenomenon	Solutions
IGBT over-temperature	IGBT is over-temperature, and it will recover grid-connected after temperature decreasing.
	Check if cooling fan of radiator is working properly.
	Check if the air vents are blocked.
	If this fault occurs repeatedly, please contact our company.
PV over-voltage	DC voltage is too high.
	Operate DC disconnecter, disconnect the connection of PV modules and inverter immediately.
	Measure the open-circuit voltage of PV array.
	Check if connection of PV module accord with inverter requirements
Communicaiton fault	Communication of liquid crystal and DSP is disconnected.
	Wait for about 10 minutes, and then observe whether the communication is normal.
	Check if the cable connection of RS485 ports is proper.



Phenomenon	Solutions
Drive fault	IGBT malfunction or drive board is in trouble.
	Check if the drive wires are loose.
	If this fault occurs repeatedly, please contact our company.
Soft start fault	Check if the sampling wire of inverter voltage is OK.
	Check if three-phase capacitance is normal.
	If this fault occurs repeatedly, please contact our company.
Grid wire connection abnormal	There is something wrong with three-phase of grid.
	Check if the connection of three-phase is correct.
	If this fault occurs repeatedly, please contact company.
Grid frequency fault	Grid frequency exceeds allowable range, and check the grid frequency is stable. If grid frequency gets right, the inverter will recover to grid-connected operation after 20 S.
	Check if the wire connection of grid is well.
Grid amplitude abnormal	Grid amplitude exceeds allowable range, and check the grid amplitude is stable. If grid amplitude returns to normal, inverter will recover to grid-connected operation after 20 S.
	Check if the wire connection of grid is well.
Hardware fault	The hardware of control system is faulty.
	If this fault occurs repeatedly, please contact our company.
Over-temperature inside the device	Temperature inside the inverter exceeds the protection point.
	Temperature inside the inverter exceeds the protection point.
	Wire of temperature switch is loose.
	If this fault occurs repeatedly, please contact our company.
Insulation fault	Check if input insulation is faulty.
	Check if the input wiring is normal.

Phenomenon	Solutions
	If this fault occurs repeatedly, please contact our company.
Fan fault	Fan is not working properly.
	Check if wire connection of fan is well
	Check if fan is blocked.
	If this fault occurs repeatedly, please contact our company.
Main contactor fault	There is something wrong with main contactor.
	Check if the wiring connection of main contactor is loose.
	If this fault occurs repeatedly, please contact our company.
Input breaker is disconnected.	Input breaker is faulty.
	Check if the wiring connection of auxiliary contactor of input breaker is loose.
	If this fault occurs repeatedly, please contact our company.
Leak current fault	Leak current exceeds the limit value.
	Check if the wiring connection of leak current is loose.
	If this fault occurs repeatedly, please contact our company.
Emergency Power Off	EPO button is pressed.
	Check if EPO button is loose.
	Check if the wiring connection of EPO button is loose.
	If this fault occurs repeatedly, please contact our company.

# A Technical Specifications

Model	SPI500K-B V4.1	SPI500K-B V4.2	SPI500K-B V4.3
Items			
Dc side			
DC input route amount	1 routes	8 routes	8 routes
Whether equipped with DC distribution breaker	None	Yes	Yes
Whether equipped with anti-reverse diode	None	None	Yes
Max. PV array power	550kWp		
Max. PV array open-circuit voltage	1000Vdc		
Max. DC current	1200A		
MPPT voltage tracking range	460~850Vdc		
Startup voltage	480Vdc		
MPPTefficiency	99.9%		
The max. reverse feedback current	0A		
Grid side			
Rated output power	500kW		
Adjusting range of output active power	0~500kW		

Items	Model	SPI500K-B V4.1	SPI500K-B V4.2	SPI500K-B V4.3
	The max. output current	1008A		
Total current wave distortion	<3% (rated power)			
Power factor	>0.99 (it can be adjusted at the range of -0.9 to +0.9)			
The max. efficiency	>98.5%			
Europe efficiency	>98.2%			
Rated grid-connected voltage	315Vac,3φ			
Rated grid-connected Frequency	50/60Hz			
Standby consumption	<150W			
Consumption at night	<80W			
Isolation type	No transformer			
Communication ports	RS232/RS485 (standard equipped), Ethernet (optional), GPRS (optional)			
Human-machine interface	LCD touch screen			
Machine parts				
Dimension(W×H×D)(mm)	1100×2000×800			
Weight(kg)	1000kg			
Environment and safety				
IP grade	IP20 (indoor)			
Cooling	Wind cooling			
Environment temperature	-25℃~55℃ (if the environment temperature more than 45℃, it need to decrease the rated power to use)			
Relative humidity	0~95%, with no condensation			
Altitude	<3000m, if the altitude exceeds 3000m , it need to decrease the rated power to use)			

Items \ Model	SPI500K-B V4.1	SPI500K-B V4.2	SPI500K-B V4.3
Noise	<75dB		

- Specifications are subject to change without prior notice.

# **B** Acronyms and Abbreviations

## **A**

**AC** Alternating Current

## **D**

**DC** Direct Current

**DSP** Digital Signal Processor

## **E**

**EPO** Emergency Power Off

## **L**

**LCD** Liquid Crystal Display

## **M**

**MPPT** Maximum Power Point Tracking

## **P**

**PV** Photovoltaic

**R**

**RS232**                      Recommend Standard232

**RS485**                      Recommend Standard485



**XIAMEN KEHUA HENGSHENG CO., LTD.**

4402-02014 001

---

ADD: No. 457, Malong Road, Torch High-Tech Industrial Zone, Xiamen, Fujian, China (361000)

TEL: 0592-5160516 (8 lines)      FAX: 0592-5162166

Http: //www.kehua.com